

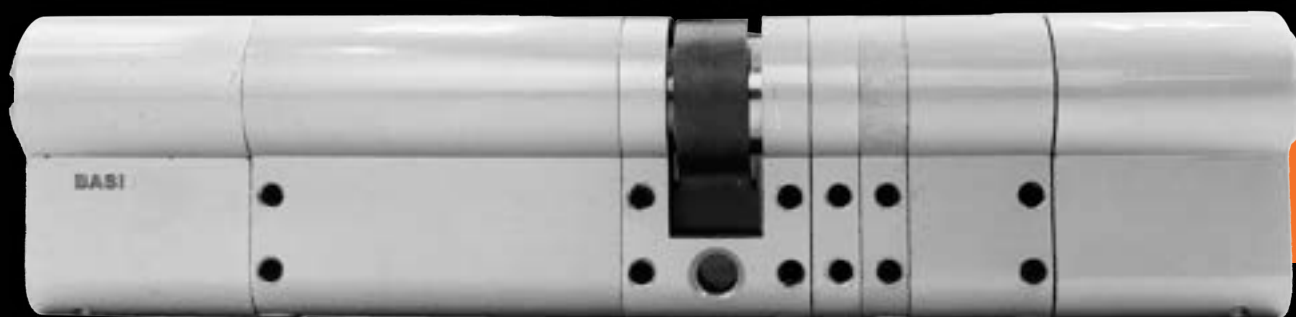

Dislock[®]



ECO BS

ECO BS

SERRETA

NIVEL 1

NEW



- Certificado EN 1303:2015
- 3 Llaves por cilindro
- 5 pines
- Acabado níquel

Opciones disponibles:

- Medio cilindro
- Doble cilindro
- Cilindro pomo
- RIM
- Candado (bajo pedido)
- Igualamientos (varias opciones consultar)
- Leva corta (consultar)
- Amaestramientos



LEVA CORTA



CONSULTAR CON DISLOCK



LLAVE EN BRUTO | Ref. ECOBSERRLL
CORTE ELECTRONICO | Ref. CEECOBSERRLL



PACKAGING



IGUALAMIENTOS

	IGUALAMIENTO	✓	Ref. IGUECOSER
	IGUALAMIENTO EN FÁBRICA*	?	CONSULTAR

AMAESTRAMIENTOS

	AMAESTRAMIENTO	✓	Ref. AMABS
	CALCULO AMAESTRAMIENTO BS SERRETA	✓	Ref. AMAFABSER



DOBLE CILINDRO

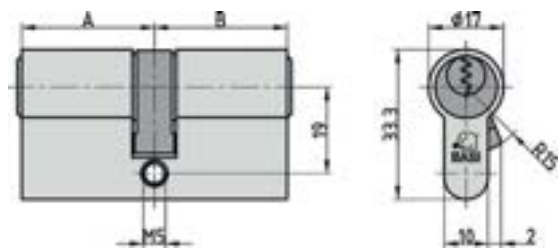

ECO BS SERRETA DOBLE CILINDRO		
A x B (mm)	REF. NIQUEL	UDS. EMBALAJE
30 X 30	EBSERR3030N	10 UDS
30 X 35	EBSERR3035N	
30 X 40	EBSERR3040N	
30 X 50	EBSERR3050N	
35 X 35	EBSERR3535N	
40 X 40	EBSERR4040N	
40 X 50	EBSERR4050N	



OPCIÓN DE IGUALAMIENTOS EN FÁBRICA

*Consultar

*Consultar otras medidas

MEDIO CILINDRO

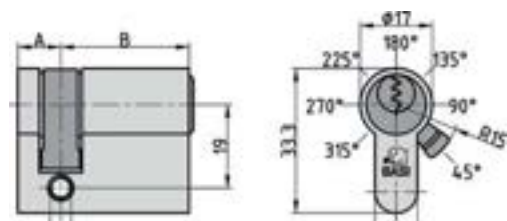

ECO BS SERRETA MEDIO CILINDRO		
A x B (mm)	REF. NIQUEL	UDS. EMBALAJE
30 X 10	EBSERR3010N	10 UDS
A x B (mm)	NEW REF. NIQUEL	UDS. EMBALAJE
35 X 10	EBSERR3510N	10 UDS



OPCIÓN DE IGUALAMIENTOS EN FÁBRICA

*Consultar

CILINDRO POMO

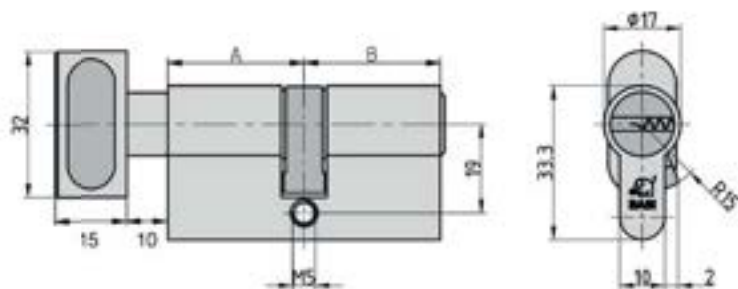

ECO BS SERRETA CILINDRO POMO		
A x B (mm)	REF. NIQUEL	UDS. EMBALAJE
30 X 30	EBSERR3030NP	10 UDS
35 X 35	EBSERR3535NP	



OPCIÓN DE IGUALAMIENTOS EN FÁBRICA

*Consultar

*Consultar otras medidas



RIM

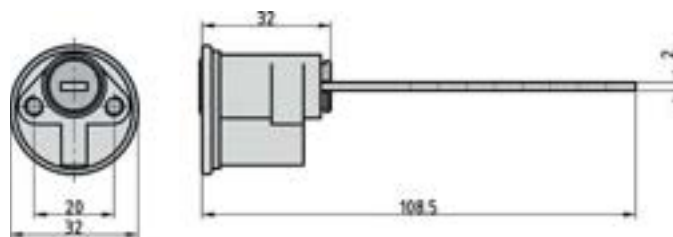

ECO BS SERRETA CILINDRO RIM	
REF. NIQUEL	UDS. EMBALAJE
EBSERRRIMN	10 UDS

CANDADO



CANDADO ECO BS SERRETA 50MM KD 3LL
REF. ECOBSERRCAN50

CANDADOS IGUALADOS

	CANDADO ECO BS SERRETA 50MM 3LL IGU KA1	<input checked="" type="checkbox"/>	Ref. EBSERCAN50KA1
	CANDADO ECO BS SERRETA 50MM 3LL IGU KA2	<input checked="" type="checkbox"/>	Ref. EBSERCAN50KA2

MALETIN ECO BS



MALETIN ECO BS SERRETA PINNING Y MONTAJE
REF. MALECOBSERR

PACK AMAESTRAMIENTO BS V50 SERRETA
REF. PACKAMAV50

ECO BS

SEGURIDAD

NIVEL **2** NEW



- 5 Llaves de puntos
- Tarjeta seguridad
- 6 pines
- Antiganzúa
- Antitaladro
- Acabado níquel

Opciones disponibles:

- Medio cilindro
- Doble cilindro
- Cilindro pomo
- RIM
- Candado (igualado bajo pedido)
- Igualamientos (varias opciones consultar)
- Leva corta (consultar)
- Amaestramientos



<p>CANDADO</p> <p>CONSULTAR CON DISLOCK</p>	<p>LEVA CORTA</p> <p>CONSULTAR CON DISLOCK</p>
--	---

LLAVE EN BRUTO | Ref. ECOBSLL
CORTE ELECTRÓNICO | Ref. CEECOBSLL



TARJETA DE SEGURIDAD



AMAESTRAMIENTOS			IGUALAMIENTOS		
	AMAESTRAMIENTO	✓ Ref. AMABS		IGUALAMIENTO	✓ Ref. IGUECOSEG
	CALCULO AMAESTRAMIENTO BS SEGURIDAD	✓ Ref. AMAFABSEG		IGUALAMIENTO EN FÁBRICA*	? CONSULTAR

DOBLE CILINDRO

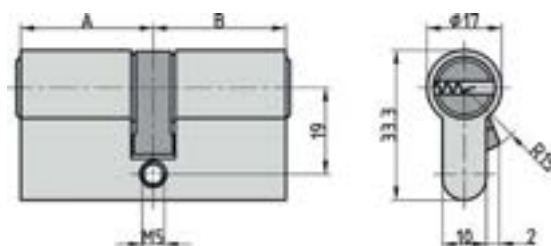

ECO BS SEGURIDAD DOBLE CILINDRO		
A x B (mm)	REF. NIQUEL	UDS. EMBALAJE
30 X 30	EBSEG3030N	10 UDS
30 X 35	EBSEG3035N	
30 X 40	EBSEG3040N	
30 X 50	EBSEG3050N	
35 X 35	EBSEG3535N	
35 X 45	EBSEG3545N	
40 X 40	EBSEG4040N	



OPCIÓN DE IGUALAMIENTOS EN FÁBRICA

*Consultar

*Consultar otras medidas

DOBLE EMBRAGUE

NEW

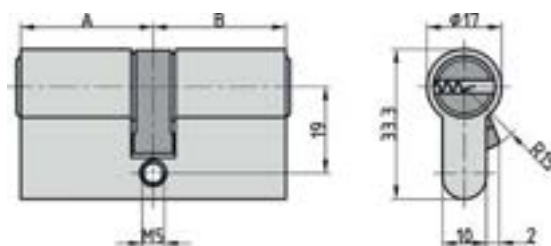

ECO BS SEGURIDAD DOBLE EMBRAGUE		
A x B (mm)	REF. NIQUEL	UDS. EMBALAJE
30 X 30	DEEBSEG3030N	10 UDS
30 X 35	DEEBSEG3035N	
30 X 40	DEEBSEG3040N	
30 X 50	DEEBSEG3050N	
30 X 55	DEEBSEG3055N**	
30 X 60	DEEBSEG3060N	
30 X 65	DEEBSEG3065N**	
30 X 70	DEEBSEG3070N**	
35 X 35	DEEBSEG3535N**	
40 X 40	DEEBSEG4040N**	
40 X 50	DEEBSEG4050N	



OPCIÓN DE IGUALAMIENTOS EN FÁBRICA

*Consultar

*Consultar otras medidas

** Bajo pedido

MEDIO CILINDRO

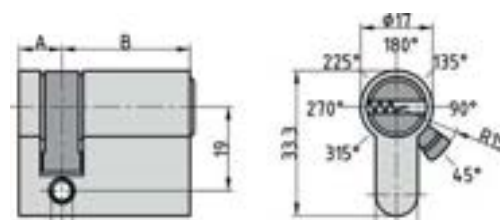

ECO BS SEGURIDAD MEDIO CILINDRO		
A x B (mm)	REF. NIQUEL	UDS. EMBALAJE
30 X 10	EBSEG3010N	10 UDS
A x B (mm)	new REF. NIQUEL	UDS. EMBALAJE
35 X 10	EBSEG3510N	10 UDS



OPCIÓN DE IGUALAMIENTOS EN FÁBRICA

*Consultar

DOBLE CILINDRO

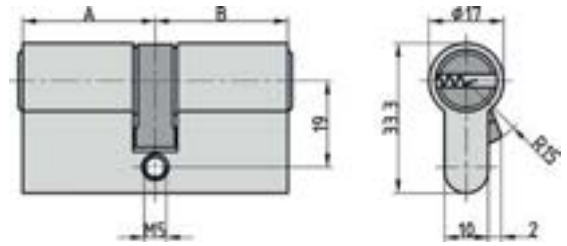

ECO BS SEGURIDAD DOBLE CILINDRO		
A x B (mm)	REF. NIQUEL	UDS. EMBALAJE
30 X 30	EBSEG3030N	10 UDS
30 X 35	EBSEG3035N	
30 X 40	EBSEG3040N	
30 X 50	EBSEG3050N	
35 X 35	EBSEG3535N	
35 X 45	EBSEG3545N	
40 X 40	EBSEG4040N	



OPCIÓN DE IGUALAMIENTOS EN FÁBRICA

*Consultar

*Consultar otras medidas

DOBLE EMBRAGUE

NEW

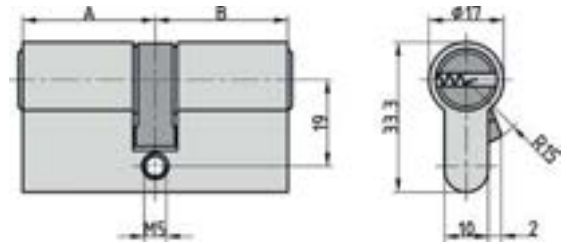

ECO BS SEGURIDAD DOBLE EMBRAGUE		
A x B (mm)	REF. NIQUEL	UDS. EMBALAJE
30 X 30	DEEBSEG3030N	10 UDS
30 X 35	DEEBSEG3035N	
30 X 40	DEEBSEG3040N	
30 X 50	DEEBSEG3050N	
30 X 55	DEEBSEG3055N**	
30 X 60	DEEBSEG3060N	
30 X 65	DEEBSEG3065N**	
30 X 70	DEEBSEG3070N**	
35 X 35	DEEBSEG3535N**	
40 X 40	DEEBSEG4040N**	
40 X 50	DEEBSEG4050N	



OPCIÓN DE IGUALAMIENTOS EN FÁBRICA

*Consultar

*Consultar otras medidas

** Bajo pedido

MEDIO CILINDRO

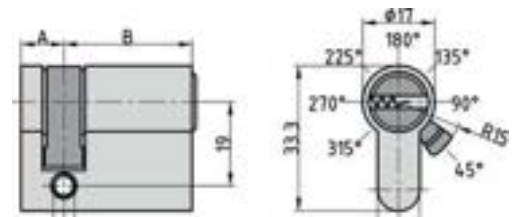

ECO BS SEGURIDAD MEDIO CILINDRO		
A x B (mm)	REF. NIQUEL	UDS. EMBALAJE
30 X 10	EBSEG3010N	10 UDS



OPCIÓN DE IGUALAMIENTOS EN FÁBRICA

*Consultar



CILINDRO POMO

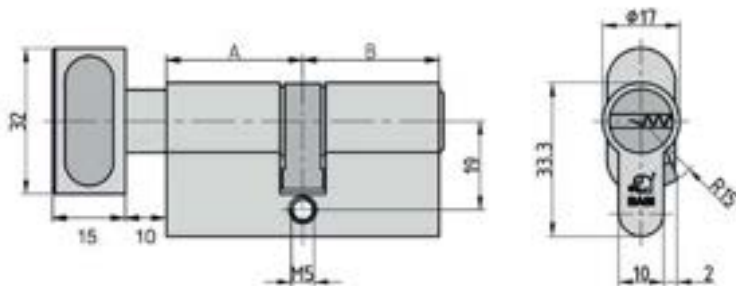

ECO BS SEGURIDAD CILINDRO POMO		
A x B (mm)	REF. NIQUEL	UDS. EMBALAJE
30 X 30	EBSEG3030NP	10 UDS
35 X 35	EBSEG3035NP	
35 X 35	EBSEG3535NP	

*Consultar otras medidas



OPCIÓN DE IGUALAMIENTOS EN FÁBRICA

*Consultar

RIM

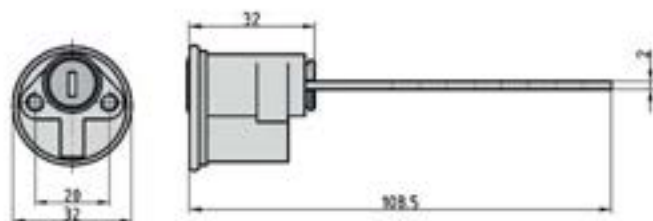

ECO BS SEGURIDAD CILINDRO RIM	
REF. NIQUEL	UDS. EMBALAJE
EBSEGRIMN	10 UDS

CANDADOS

NEW



CANDADO ECO BS SEGURIDAD 50MM KD 3LL	
REF. ECOBSEGCAN50	1 UDS
REF. ECOBSEGCAN50	1 UDS

CANDADOS IGUALADOS



CANDADO ECO BS SEGURIDAD 50MM 3LL IGU KA1	✓	Ref. EBSEGCAN50KA1
CANDADO ECO BS SEGURIDAD 50MM 3LL IGU KA2	✓	Ref. EBSEGCAN50KA2

MALETIN ECO BS



MALETIN ECO BS SEGURIDAD PINNING Y MONTAJE	
REF. MALECOBSEG	1 UDS
PACK AMAESTRAMIENTO BS V55 SEGURIDAD	
REF. PACKAMAV55	1 UDS

ECO BS TRIANGULAR

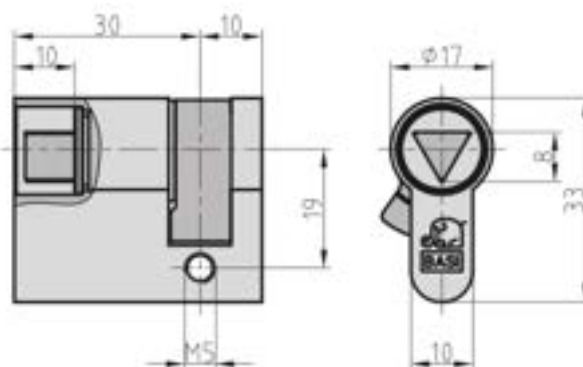

CILINDRO ESPECIAL LLAVE TRIANGULAR	
REF. NIQUEL	UDS. EMBALAJE
DM50200000DI8	



LLAVE DE BLOQUEO TRIANGULAR 8mm	UDS. EMBALAJE
301D-8	1

ECO BASI M|O|D|U|L|A|R

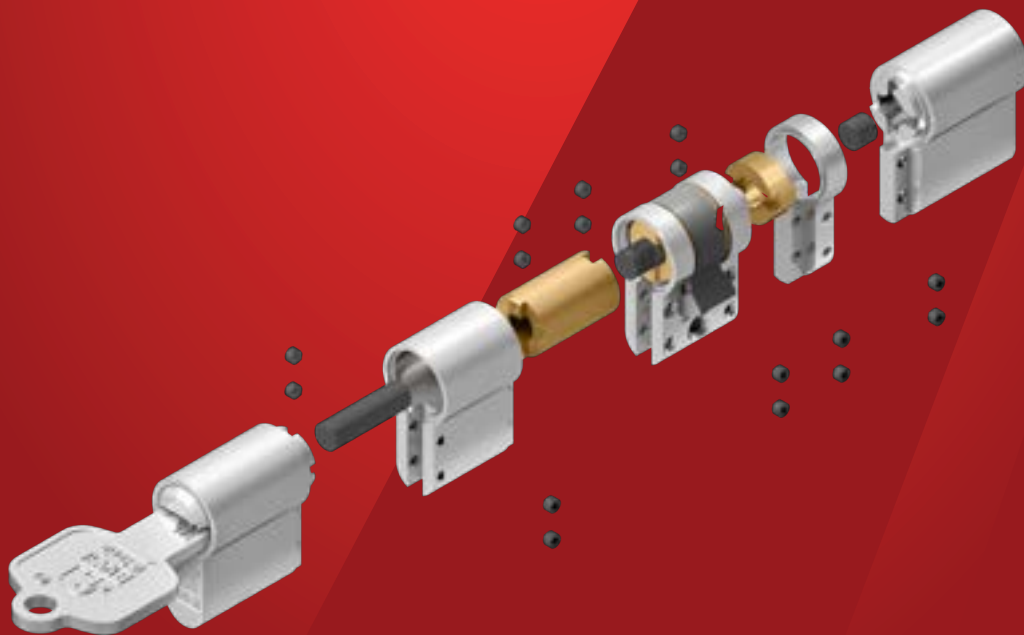

SERRETA



SEGURIDAD

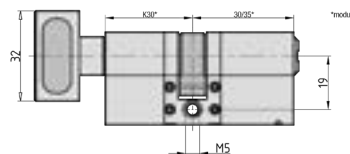
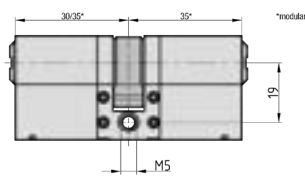
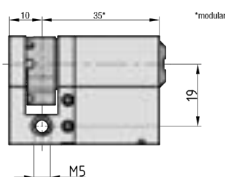
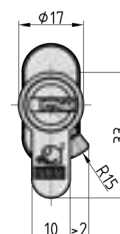
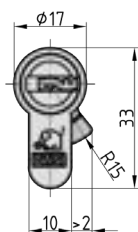

SERRETA

REF.	DESCRIPCIÓN
EBSRM1035N	CILINDRO ECO BS MODULAR SERRETA 10x35* NIQUEL
REF.	DESCRIPCIÓN
EBSRM3030NP	CIL. POMO ECO BS MODULAR SERRETA 30X30* NIQUEL
EBSRM3035NP	CIL. POMO ECO BS MODULAR SERRETA 30*X35* NIQUEL
REF.	DESCRIPCIÓN
EBSRM3035N	CILINDRO ECO BS MODULAR SERRETA 30X35* NIQUEL
EBSRM3535N	CILINDRO ECO BS MODULAR SERRETA 35*X35* NIQUEL





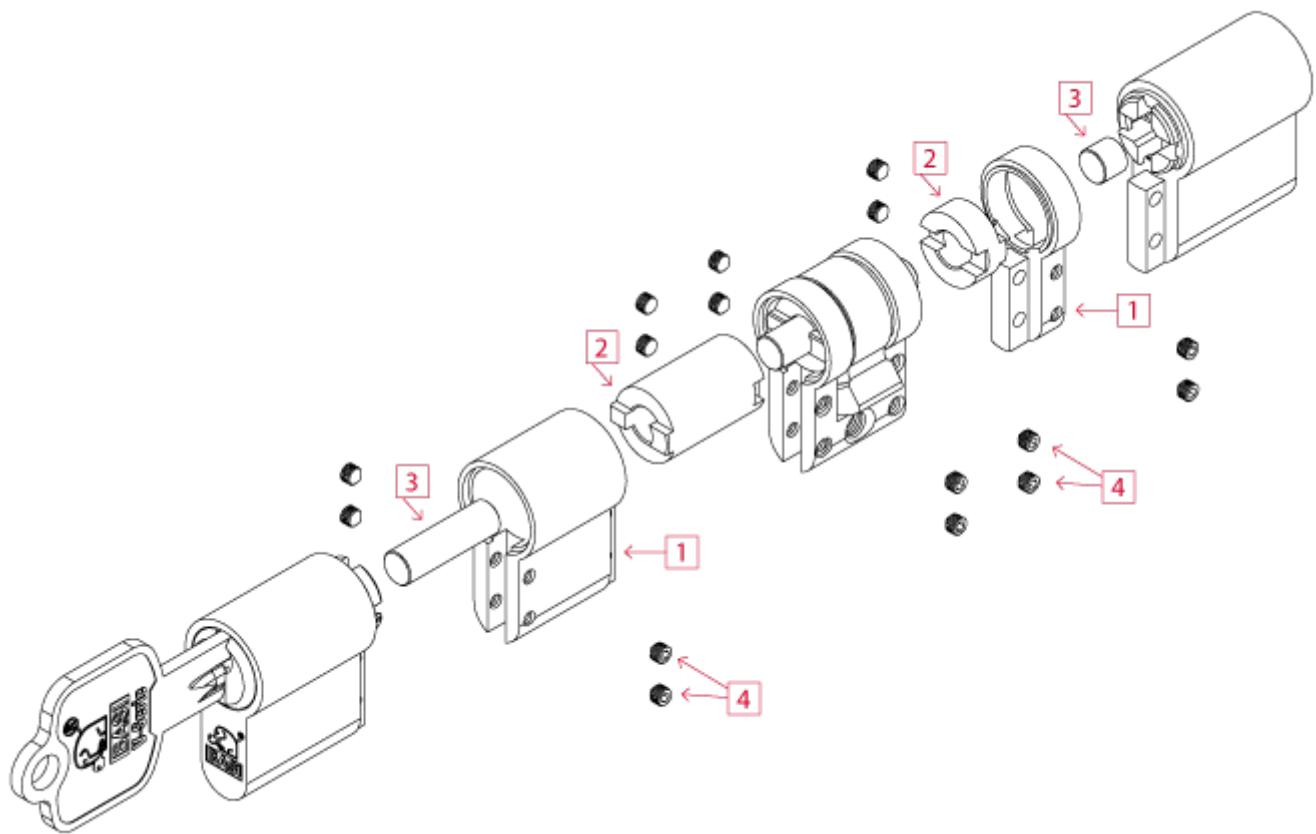

SEGURIDAD

REF.	DESCRIPCIÓN
EBSGM1035N	CILINDRO ECO BS MODULAR SEGURIDAD 10x35* NIQUEL
REF.	DESCRIPCIÓN
EBSGM3030NP	CIL. POMO ECO BS MODULAR SEGURIDAD 30X30* NIQUEL
EBSGM3035NP	CIL. POMO ECO BS MODULAR SEGURIDAD 30*X35* NIQUEL
REF.	DESCRIPCIÓN
EBSGM3035N	CILINDRO ECO BS MODULAR SEGURIDAD 30X35* NIQUEL
EBSGM3535N	CILINDRO ECO BS MODULAR SEGURIDAD 35*X35* NIQUEL





COD ART	TIPO DE COMPONENTE	DESCRIPCIÓN	CANTIDAD BOLSA				
V50/V55 MODULAR EXTENSIÓN ROTOR							
1	5900-0370 5900-0371 5900-0372 5900-0373 5900-0374 5900-0375 5900-0376 5900-0377 5900-0378 5900-0379	 EXTENSIÓN ROTOR	EXTENSIÓN ROTOR 5MM EXTENSIÓN ROTOR 10MM EXTENSIÓN ROTOR 15MM EXTENSIÓN ROTOR 20MM EXTENSIÓN ROTOR 25MM EXTENSIÓN ROTOR 30MM EXTENSIÓN ROTOR 35MM EXTENSIÓN ROTOR 40MM EXTENSIÓN ROTOR 45MM EXTENSIÓN ROTOR 50MM	PU = 10 piezas PU = 8 piezas PU = 6 piezas PU = 4 piezas PU = 2 piezas PU = 2 piezas PU = 2 piezas PU = 2 piezas PU = 2 piezas PU = 2 piezas			
	V50/V55 MODULAR EXTENSIÓN CUERPO						
	2	5900-0390 5900-0391 5900-0392 5900-0393 5900-0394 5900-0395 5900-0396 5900-0397 5900-0398 5900-0399	 EXTENSIÓN CUERPO	EXTENSIÓN CUERPO 5MM EXTENSIÓN CUERPO 10MM EXTENSIÓN CUERPO 15MM EXTENSIÓN CUERPO 20MM EXTENSIÓN CUERPO 25MM EXTENSIÓN CUERPO 30MM EXTENSIÓN CUERPO 35MM EXTENSIÓN CUERPO 40MM EXTENSIÓN CUERPO 45MM EXTENSIÓN CUERPO 50MM	PU = 10 piezas PU = 8 piezas PU = 6 piezas PU = 4 piezas PU = 2 piezas PU = 2 piezas PU = 2 piezas PU = 2 piezas PU = 2 piezas PU = 2 piezas PU = 2 piezas		
		V50/V55 MODULAR EXTENSIÓN EJE					
		3	5900-0400 5900-0401 5900-0402 5900-0403 5900-0404 5900-0405 5900-0406 5900-0407 5900-0408 5900-0409	 EXTENSIÓN EJE	EXTENSIÓN EJE 5MM EXTENSIÓN EJE 10MM EXTENSIÓN EJE 15MM EXTENSIÓN EJE 20MM EXTENSIÓN EJE 25MM EXTENSIÓN EJE 30MM EXTENSIÓN EJE 35MM EXTENSIÓN EJE 40MM EXTENSIÓN EJE 45MM EXTENSIÓN EJE 50MM	PU = 10 piezas PU = 8 piezas PU = 6 piezas PU = 4 piezas PU = 2 piezas PU = 2 piezas PU = 2 piezas PU = 2 piezas PU = 2 piezas PU = 2 piezas	
			V50/V55 TORNILLERÍA				
			4	5900-0420	 PRISIONERO 1,5MM (100 UDS)	PRISIONERO 1,5MM	100 piezas

REF.
MALECOMODULAR





Dislock[®]